

Etienne

Productsheet



Elements of the collection (dimensions: wide, deep, high)

Explanation of the elements:

W = Element with armrests on both sides
L/R = Element with armrest on the left or right side
L = Element with armrest on the left side
R = Element with armrest on the right side

N = Element with no armrest
P = Pouffe element
DP = Decorative Pillow

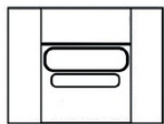

1,7 W
120 x 118 x 86 cm

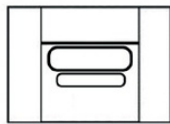

1,8 W
130 x 118 x 86 cm

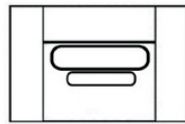

1,9 W
140 x 118 x 86 cm

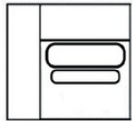

1,7 L/R
98 x 118 x 86 cm

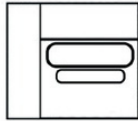

1,8 L/R
105 x 118 x 86 cm

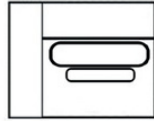

1,9 L/R
115 x 118 x 86 cm

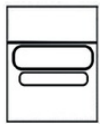

1,7 N
70 x 118 x 86 cm

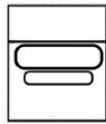

1,8 N
80 x 118 x 86 cm

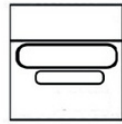

1,9 N
90 x 118 x 86 cm



2,4
190 x 118 x 86 cm



3,6
210 x 118 x 86 cm

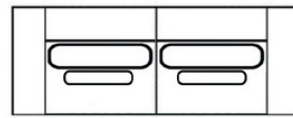

3,8
230 x 118 x 86 cm



2,4 L/R
165 x 118 x 86 cm

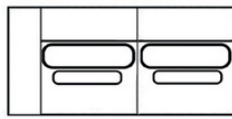

3,6 L/R
185 x 118 x 86 cm

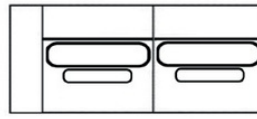

3,8 L/R
205 x 118 x 86 cm

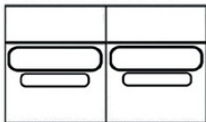

2,4 N
140 x 118 x 86 cm

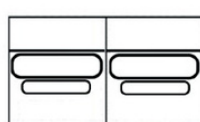

3,6 N
160 x 118 x 86 cm



3,8 N
180 x 118 x 86 cm

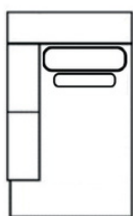

OTML/R
232 x 118 x 86 cm



ML/R
116 x 205 x 86 cm

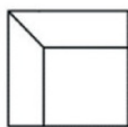

C
16 x 116 x 86 cm



P (90x70)
90 x 70 x 48 cm

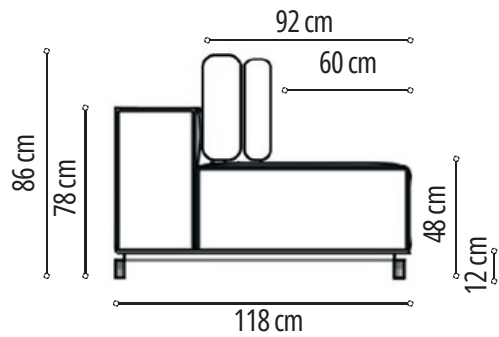

Accessories:



DP.1
40 x 40 cm



DP.2
50 x 50 cm



DP.3
35 x 65 cm